



MultiCam register marks for Commercial and Newspaper printers

MultiCam provides both circumferential and lateral color register control in a compact, low profile system. It identifies register marks as small as 0.014 in. (0,36 mm) as well as Ribbon Control, Autotron™, and other manufacturers' marks at speeds up to 3,500 ft/min (17,8 M/sec).

Lateral mark patterns

MultiCam offers multiple *lateral* mark patterns to meet a range of printing needs. The camera can read four, six, or eight colors *across*.

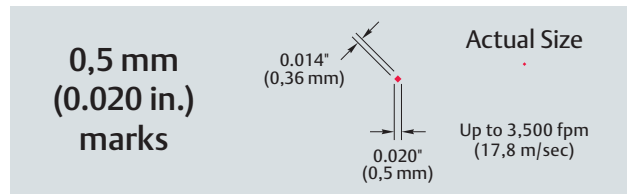
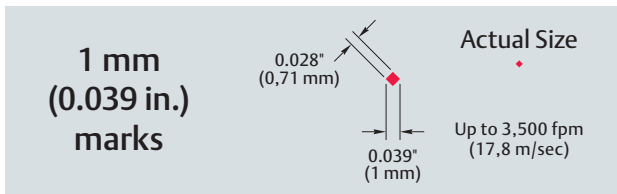

White Space Requirements

White Space Requirements

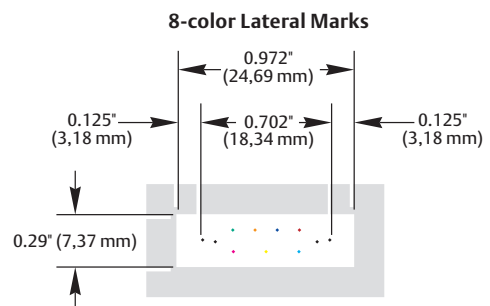
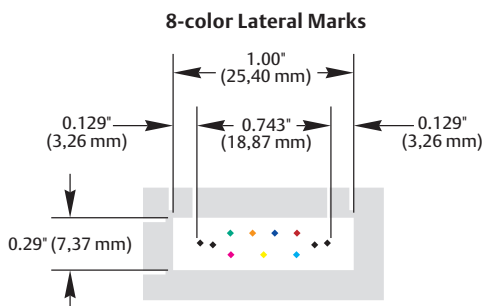
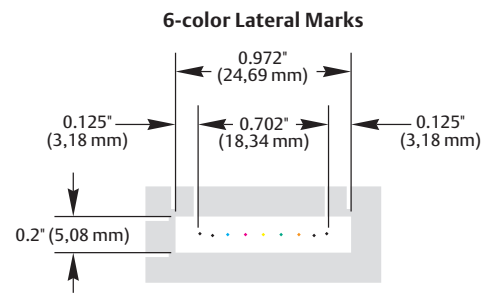
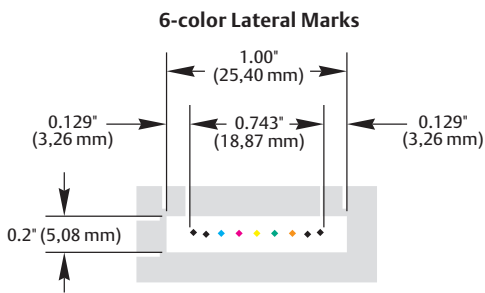
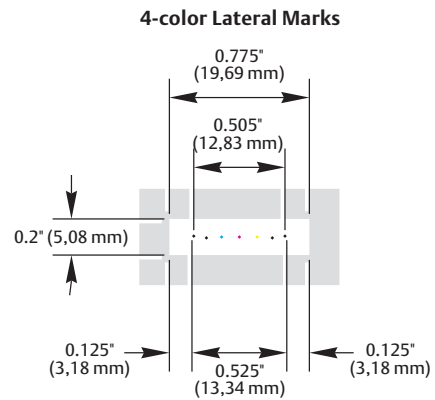
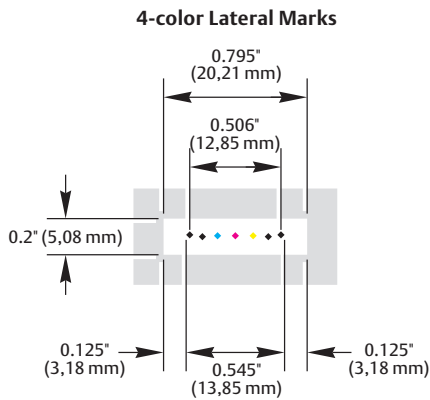

Circumferential mark patterns

MultiCam offers multiple *circumferential* mark patterns to meet a range of printing needs. The camera can read four, six, or eight colors *ahead*.

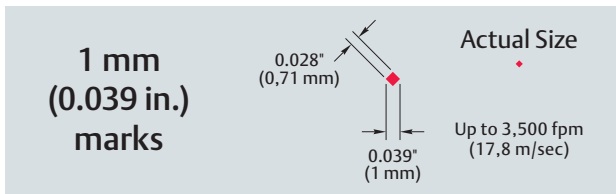

White Space Requirements

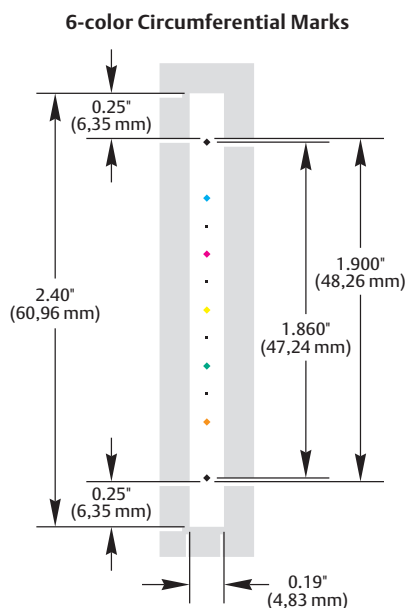
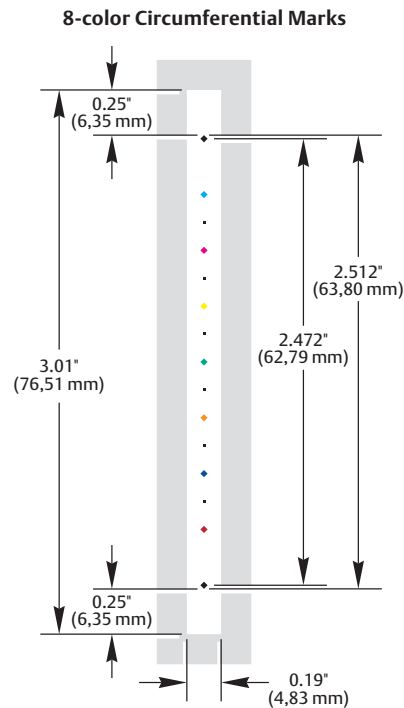
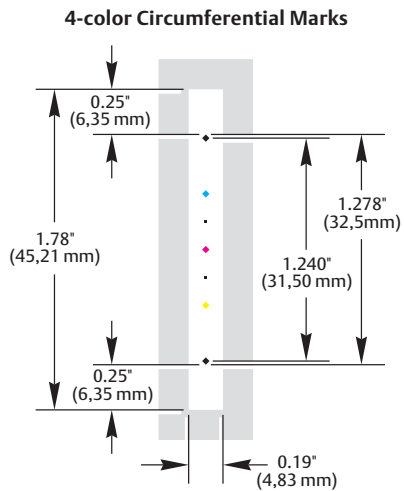

Circumferential mark patterns (continued)

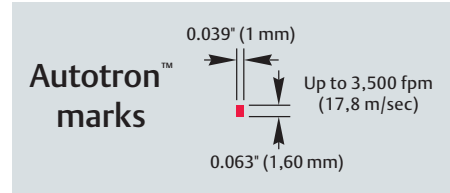
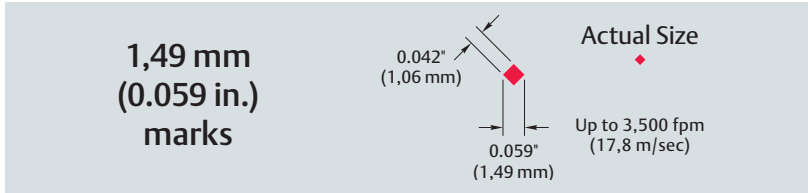

White Space Requirements

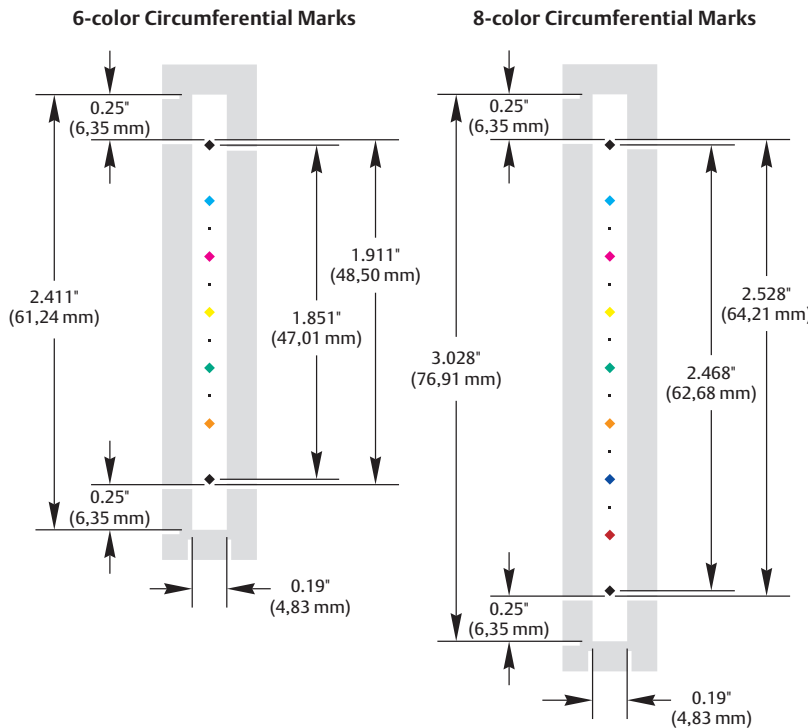

White Space Requirements

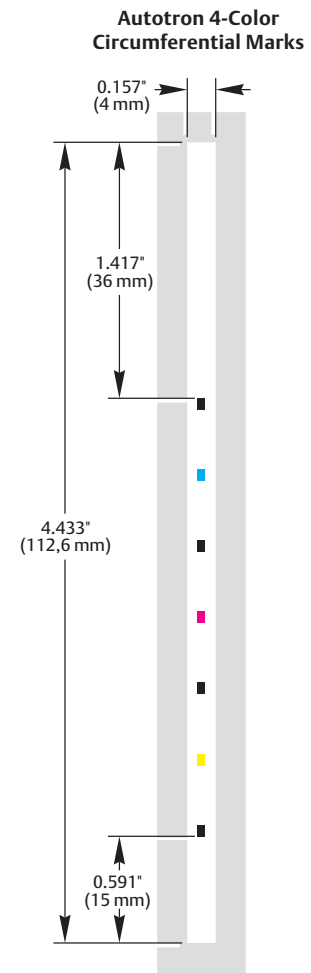

Also available Autotron 5 & 6 color patterns

Ribbon Control marks

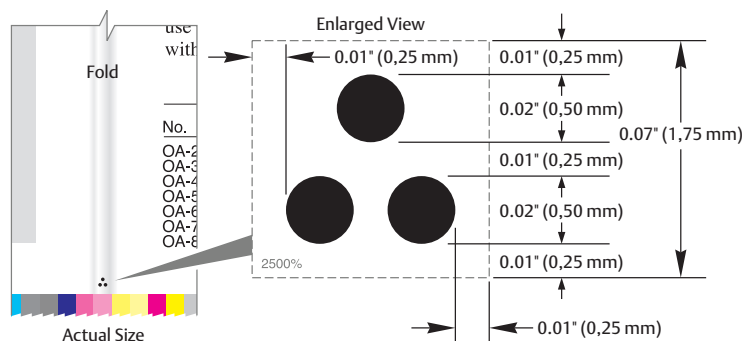

Publication nr. 2018T1_ENGLISH

Contact

Email: visionsolutions@baldwintech.com

For regional contacts please visit baldwintech.com

Follow

